

# RGB LED FLEX STRIP

Model: **FA60M50-XM-24V-RGB** (X: 2m (6.56ft), 6m (19.7ft))

**LED WORLD**  
ledworldlighting.com | ledworld.ca  
1-800-387-4081

## IMPORTANT INSTRUCTIONS



Never Nail or use Staples



Never apply weights or walk on strips



Only power with 24VDC  
Class 2 Power Source



Apply to surface at room temperature. Keep away from flammable materials. Surface temperature MAX 40°C (104°F). Don't install under, above or near heat sources (i.e. stoves, fireplaces)

## Safety & Warnings

Please read instructions before using product and **SAVE THESE INSTRUCTIONS**. Before using this product make sure you have right color, product (item number) and voltage (printed on product). Check for possibility of damage during shipping. If damaged, or wrong product, **do not use**. Disconnect power before installing or using.

**Use only with Class 2 Type power supply. Using with any other type of power supply will void the limited warranty.**

Use only with LED World's Class 2 Type power supply.

Indoor use, Dry locations. Do not expose LED Flex Strip to moisture.

Disconnect power before installing or servicing (at breaker point).

This product is intended to be installed and serviced by a qualified licensed electrician. Install in accordance with the National Electric Code, and local regulations.

Only power with a (listed) constant voltage Class 2 power supply (24V DC).

Never plug into 120V AC. The product requires a optional class 2 Transformer.

- **Do not power when rolled.** Lighting must be installed in a straight line on a flat surface. Do not curl or twist and roll out completely straight before applying power.
- Only install on smooth flat surfaces free of burrows that are fire retardant.
- Product has an adhesive tape on back. Adhesion can only be made once and the LED strip must **fully adhere to surface** (flush). Failure to do this step will damage product. Rigidly support wires with wire clamps.
- During installation, do not damage the printed circuit. Exposed wires can cause short circuit damaging product and creating a serious hazard. Do not mount in a manner or support LED Strip light in a manner that can damage the outer jacket or cord insulation. Do not install this lighting system where the exposed bare conductors can be shorted or contact any conductive materials. Carefully check that there is no wire cross-over or possibility in the future in area of installation.
- To reduce the risk of fire and overheating, make sure all connections are tight.
- Product is sold in the maximum length. **Do not exceed or extend the length of the roll.**
- Only qualified electrician or engineer can perform installation familiar with low voltage wiring techniques. Correct polarity is imperative (+/- is marked on printed circuit). Parallel connection only.
- DO NOT install on flammable material or possibility of in the future. Do not install any luminaire closer than 6 inches (15.25 cm) from any curtain, or similar combustible materials.
- The light and all its components cannot be mechanically pressed. Never apply to surface above 40c (104F).
- Voltage must not exceed **24VDC** and must be regulated. The Voltage is printed every 6 LEDs. Check that it is the correct voltage before applying power.
- This is not a toy. Keep out of children's reach.
- Keep Flex strip spaced 3/4" apart if placing next to each other.
- LED Flex Strip is bendable on one flat widest plane. Maximum bend radius is 4 inches (100mm) on one plane (flat).
- Not for use in mission critical, aircraft, emergency signs or lifesaving equipment.
- Static electricity can damage LED(s). Handle with care.
- Inspect installation after one hour and thereafter regularly.
- For stationary use only and not subjected to possible pressure or movement (or in the future).
- Not for in-wall use.
- Max. Soldering temperature cannot exceed 250°C (482°F) for a max of 4 seconds. Use 22~20 AWG wire to connect.
- Use correct wiring as required by local electrical code. Use a 20 gauge wire to attach to strip by solder (2464 type of wire). Connection to power source may use Wago™ 222-413 in hardwire applications.
- Cable lighting systems not be installed in bathrooms.
- Conductors of extra-low-voltage circuits be rigidly supported.
- Conductors not be installed in contact with combustible materials and not run through walls, ceilings, floors or partitions, and; Uninsulated conductors not be installed less than 2.2 m (86") from the floor.
- Do not stare **directly** into the LED Light. Install LED lighting out of direct sight.

### THREE YEAR LIMITED LIGHTING WARRANTY

LED WORLD INC. warrants this product for three year (some exceptions may apply) from the date of shipping unless otherwise noted in writing. This warranty is expressly in lieu of all other warranties expressed or implied. Under this Limited Warranty, the obligation of the company is limited to replacing on a prorated basis, at its option, any component found to be defective. This Limited Warranty does not apply to damage caused by buyer or alteration to the product or incorrect power supply. Factory warranties are covered by the original manufacturer and claims must be submitted to them. This product must be used with LED World's class 2 power supply. Failure to do so will void limited warranty.

LED World Inc. And its providers will never be liable to you or any other person for any indirect, incidental, consequential, special, punitive or exemplary loss or damage arising from, connected with, the purchase of products, including but not limited to loss of data, business, markets, cost of labour, savings, income, profits, use, production, reputation or goodwill, anticipated or otherwise, or economic loss, under any theory of liability (whether in contract, tort, strict liability or any other theory or law or equity), regardless of any negligence or other fault or wrongdoing (including without limitation gross negligence and fundamental breach) by led world inc or any person for whom led world inc is responsible, and even if led world inc has been advised of the possibility of such loss or damage being incurred.

If a product is defective, we will replace the product with similar or identical product or at our option a credit towards a future purchase. To make a claim under this warranty, obtain a return authorization number.

# RGB LED FLEX STRIP

Model: FA60M50-XM-24V-RGB (X: 2m (6.56ft), 6m (19.7ft))

## IMPORTANT INSTRUCTIONS

### APPLICATIONS

- Back Lighting
- Cove Lighting
- Task Lighting
- Display Lighting
- Lighting Store
- Under Cabinet Lighting
- Accent Lighting
- Sign Lighting

### FLEX STRIP CONNECTION

Wire connection using WAGO block connectors

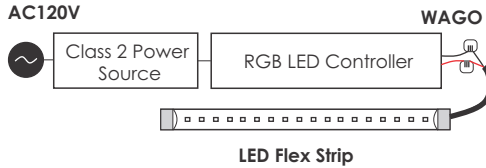

Cut instructions

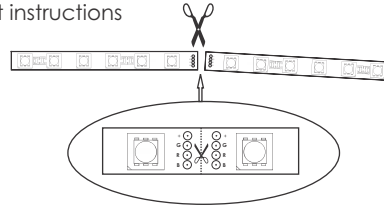

Solder Connection Points



Solder connection points are at marked intervals. Cut points are at every 6 LEDs (24VDC)

### INSTALLATION PLANNING

LED Flexstrip is a versatile lighting product that can provide a superior lighting solution in a variety of applications.

**Recommend design steps before starting the installation process:**

General questions based on lighting requirements:

- Where will your power supply be located
- How will you switch your LED lighting ON and OFF?
- What is the best layout configuration for your installation with wiring consideration?
- How will you run your wiring to your LED strip lighting?

#### IMPORTANT NOTE

Mount Strips on Clean (No Wax/Oil), dry, smooth, burrows free surface. Adhesion can be made once and LED Strip must fully adhere to surface.

### WATTAGE CALCULATION

The LED Flex Strips have a label on each roll that indicates the voltage and wattage. You must have the correct Class 2 Power Supply (Transformer) for LED Strip model. To calculate the wattage, measure the total length of LED Strip in your run multiplied by the wattage of the LED Strip. Remember that a power source should only operate at a maximum 80% of it rated capacity.

**For example:** 10 feet of FA60M50-5M-24V-RGB x 4.4W = 44 Watts

### WIRING FOR VOLTAGE DROP

Voltage drop is normal loss of voltage that occurs as power flows along a wire connection in a low voltage systems, and increases as the length of a wire connection is increased. Wire length and thickness as well as total light wattage influence the amount of voltage drop.

Recommended maximum wire lengths - 24VDC						
Wire Gauge (AWG)	20W	30W	50W	60W	90W	100W
20 AWG	27 FEET	18 FEET	11 FEET	9 FEET	6 FEET	5 FEET
18 AWG	42 FEET	28 FEET	17 FEET	14 FEET	9 FEET	8 FEET
16 AWG	67 FEET	45 FEET	27 FEET	22 FEET	15 FEET	13 FEET

Download Magnitude app for voltage drop calculations:



Android App



iOS App

# RGB LED FLEX STRIP

Model: FA60M50-XM-24V-RGB (X: 2m (6.56ft), 6m (19.7ft))

## LAYOUT OPTIONS

**Note:** Always check the Wattage of your LED Strip or Fixture.  
Power Supply Wattage x 0.8 = Available Wattage

Class 2 Power Supply

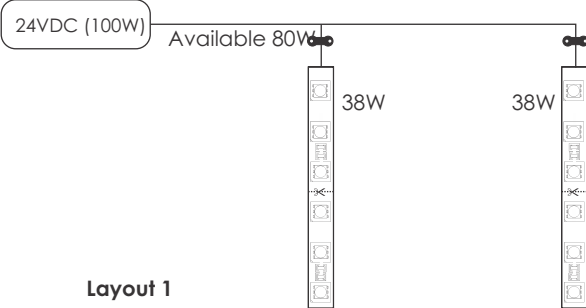

Class 2 Power Supply

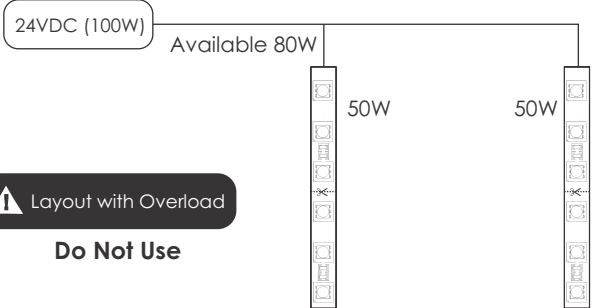

Class 2 Power Supply

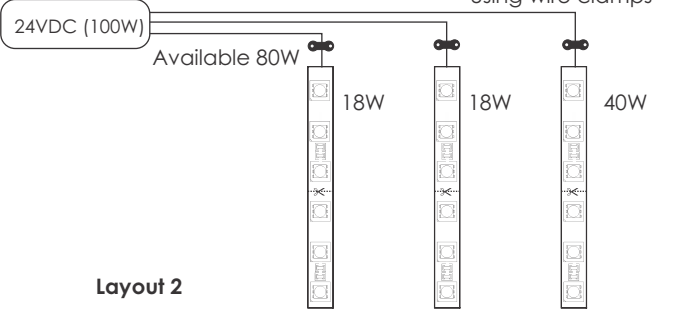

Class 2 Power Supply

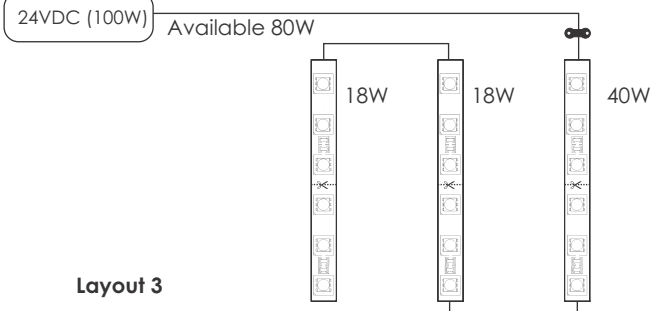

## LED STRIP CUTTING

Our strips comes with cut mark sign. Strips are be cuttable at each 3 LEDs. Cut marks lying between set of soldering points.

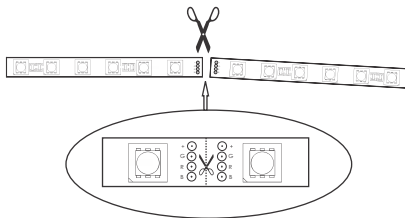

## CONNECT WITH RGB QUICK CONNECTORS/SOLDERING

There are many options available for connecting LED light strips. Right diagram shows how connect using our RGB Quick Connectors. However it is strongly recommend to solder the connection. Please refer to our quick connector instruction sheet.

**Note: Peel 3M tape before using with Quick Connectors**

Soldered Contacts

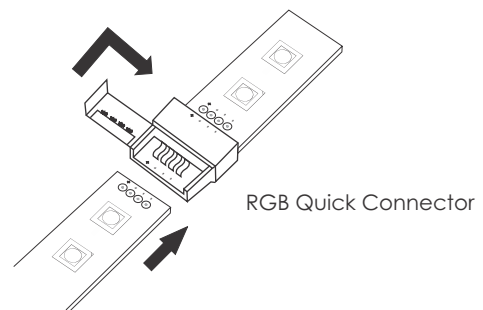
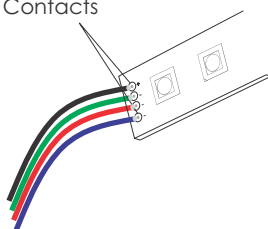

RGB Quick Connector

## IMPORTANT INSTRUCTIONS

### CONNECT WITH RGB STRIP CONNECTOR CORD

Another option for quick, easy and flexible connection between RGB LED strips is our RGB Strip Connector Cord. RGB Strip Connector Cord are useful option in application where you want to easily joint light strips over separated surfaces, such as between kitchen cabinet.

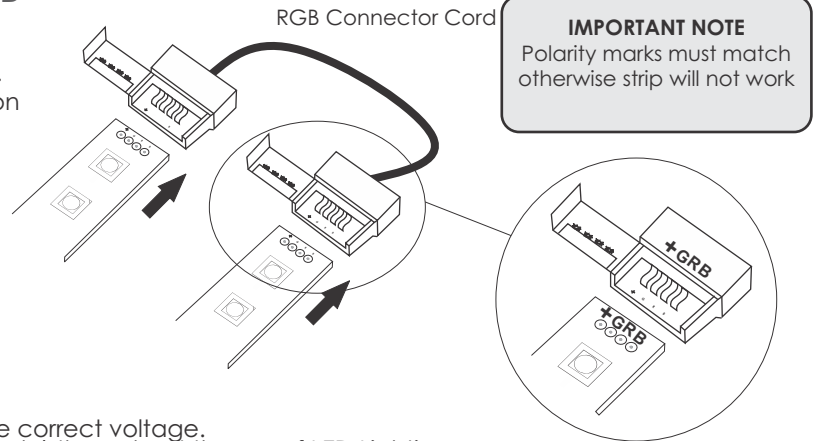

### TROUBLESHOOTING

#### Tape light strip does not light

- Make sure your power supply is turned on and has the correct voltage.
- Confirm you have the correct polarity (+ to + and - and -) throughout the run of LED Lighting.
- Have a electrician check all connections and any switch or dimmer connections from the power supply to the LED Light Strips.
- Consider testing with a multimeter to ensure light strip is receiving 24V power.

#### LED Flex Strip lights blink on, then go off

- The power supply is not adequate for the length of LED Light Strips you are powering. Install a adequate Class 2 power supply.

#### LEDs farthest from the power supply are noticeably dimmer

- This is the result of voltage drop. Decrease the length of the 24V power feed or use thicker power feed wires between the 24V power supply and the lighting strips.

### IMPORTANT !



Apply 1 1/2" long electrical heat shrink over all connection points. Secure connection wire with wire clamp.

**Note: Diagram below shows 2 wire, but RGB strip will have 4 wires**

maximum band radius 4"



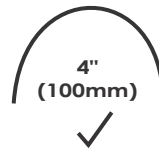

Wrong!

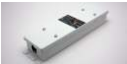

On widest one flat plane (only)  
 Do not bend sideways.  
 Flexible on one axis

### MAXIMUM FLEXSTRIP LENGTH SUPPORTED BY LED WORLD'S CLASS 2 POWER SUPPLY

Power Supply	Max Feet of LED Flexstrips	Power Supply	Max Feet of LED Flexstrips
 <b>CVN96L24DC</b>	16.4 Feet (5 meter)	 <b>XLD200B-224V-FC</b>	2 X 18.18 feet (Each Channel) Total 36.36 feet (10 meter)
 <b>MHP-240375</b>	16.4 Feet (5 meter)		