

12VDC 300W Triac/0-10V Dimmable LED Driver

Model: MD-012-300VTD52JV2

LED WORLD
ledworldlighting.com | ledworld.ca
1-800-387-4081

PRECAUTIONS BEFORE INSTALLING

- Read all instructions before installation. To be sold with instructions.
- Only qualified personnel should install the unit.
- Installation must comply with the National Electrical Code (Article 450) and Canadian Electrical Code.
- Ensure the unit has the proper input/output voltage and output wattage for your application.
- Check the wire markings to ensure they match the wiring diagram on this installation guide.
- Turn off power at breaker before starting.



INSTALLATION GUIDELINES

- The driver must be installed in a well-ventilated area free from explosives gases and vapors. Proper operation requires for free flow of air. Do not install inside a cabinet smaller than 12 W x 12 H x 15 L inches. If you are installing multiple drivers, keep a minimum space of 5" (127mm) between each driver. For Indoor or Outdoor use.
- Operate only within specified ambient temperature range of 4°F (-20°C) to 104°F (40°C). Operating at cooler surrounding air temperature will extend driver life.
- Do not overload. Total wattage of all LED fixtures used must not exceed the 300 watt rating of this power supply. Maximum of 48 watt in each output for continuous use.
- Route and secure wires so they will not be pinched or damaged.
- All wiring must be in accordance with NEC/CEC, low voltage Class 2 circuit. For wire runs inside of walls, use properly certified CL2 or better cabling and appropriate mounting hardware. If you are unclear as to how to install and wire this product, contact a qualified licensed electrician. Failure to install this device properly may result in electrical shock or fire.
- Do not install Class 2 low voltage wiring in the same run(s) as AC main power.

MOUNTING

Select a suitable location capable of supporting the weight of the transformer. Use the four keyholes on the transformer case. Screw cover closed. Mount the unit at a height greater than 1ft (30cm) from the ground.



If used outdoors, the knockouts must point downward

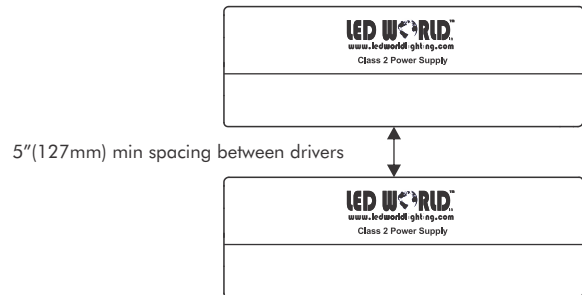

INPUT CONNECTIONS / GROUNDING

- Remove the wiring cover (2 screws). Remove the wiring compartment knockout and install strain reliefs (not included). With power turned off at the breaker, route the input wires. Connect one wire to black(L) and one wire to white(N) to the corresponding pigtail wire.
- For all wire connections use only UL/CSA listed wire nuts or wago connectors of suitable size and type.
- The Driver case **MUST** be grounded in accordance with the NEC/CEC. Connect the ground wire to the driver green wire.
- Use 3/8" (1/2" KO) cable connectors (not included) to secure wire.
- If used outdoor, must have knockouts point downwards. Use only outdoor rated UL/CSA listed strain relief (water tight).
- Maximum of 12AWG through branch circuit conductor suitable for 105°C (221°F) permitted in box.

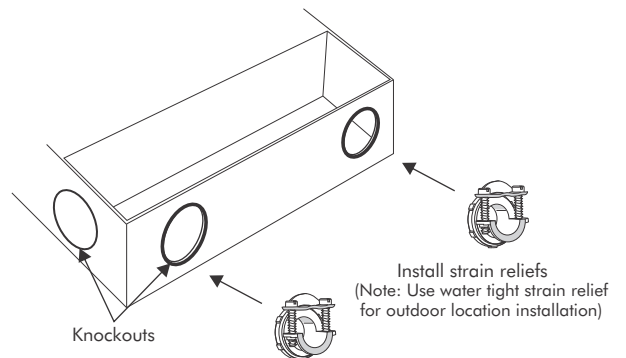

OUTPUT CONNECTIONS (LOW VOLTAGE)

- Connect the wires of the light fixture to the driver wires - positive to the red(+) wire and negative to black(-) wire.
- Measure the output voltage for proper voltage to LED fixture.
- **WARNING - Do not interconnect output terminations. Risk of Fire or Electric Shock.**
- After all wiring completion, screw in wiring cover.

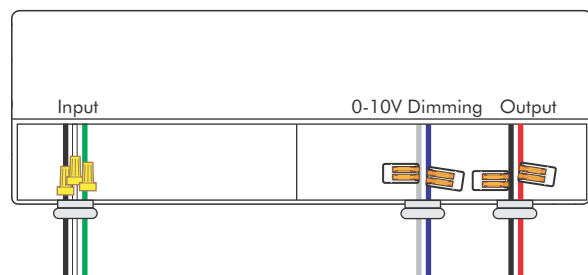

Use appropriate UL/CSA listed wire nuts or wago connectors (not included) to connect wires

Green (G) Grey (-) Red (V+)
White (N) Purple (+) Black (V-)
Black (L)

12VDC 300W Triac/0-10V Dimmable LED Driver

Model: MD-012-300VTD52JV2

DIMMING

- **Triac Dimming:** Connect Phase type dimmer to the input of the LED driver. (Forward Phase, Magnetic Low Voltage and Triac dimmer). See website for compatible dimmer list. See Triac dimming diagram.
- **0-10V Dimming:** Connect 0-10V type dimmer to the grey and purple wires on the output of the driver. See 0-10V dimming diagram.
- Connect Input terminal (L/N) wires as shown in no dimming diagram.
- Connect LED Fixture to the output terminal(s) (low voltage) wires.
- A ground wire to be attached to the input side of the junction box to ground.

CONNECTION DIAGRAM

NOTE: Use only one dimming method. Do not combine dimming methods.

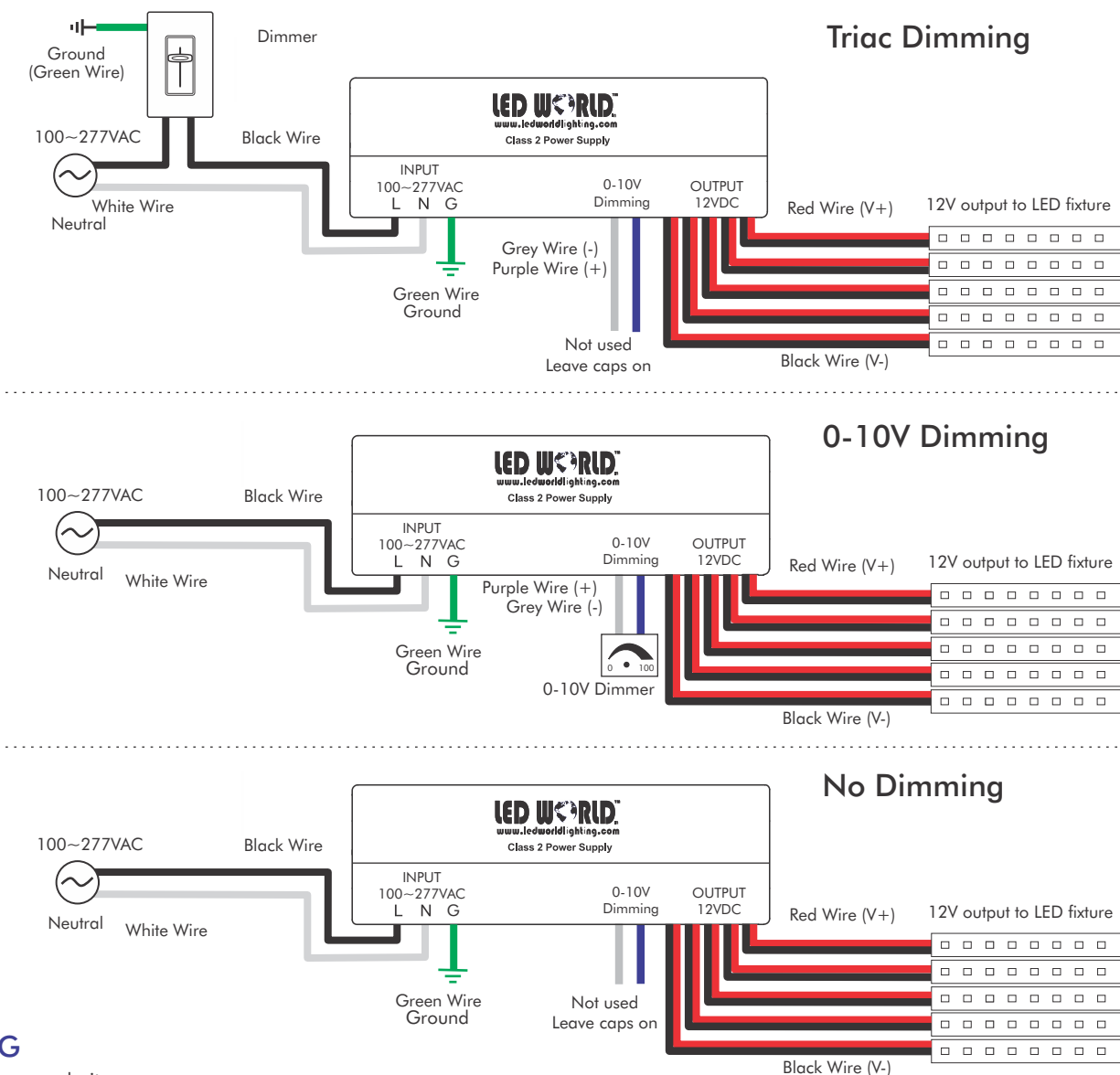

WARNING

- Prevent reverse polarity.
- The LED Driver is not to be repaired. Do not use if it is damaged or defective.
- Installation involves special wiring methods to run wiring through a building structure. Consult a qualified licensed electrician.

TROUBLESHOOTING

Do not exceed 48 watts of continuous load in each output. Note the wattage information on the item (strip label) that is being powered. If wattage or amperage information is not available or unknown, do not use. Power supply may be very warm if overloaded and will damage the unit (void limited warranty).

This device complies with FCC 47 CFR Part 15, Part B. Operation is subject to the following two conditions: (1) May not cause harmful interference, (2) Must accept any interference received, including interference that may cause undesired operation.